

**BLADE<sup>®</sup>**

**70S**

**Instruction Manual  
Bedienungsanleitung  
Manuel d'utilisation  
Manuale di istruzioni**

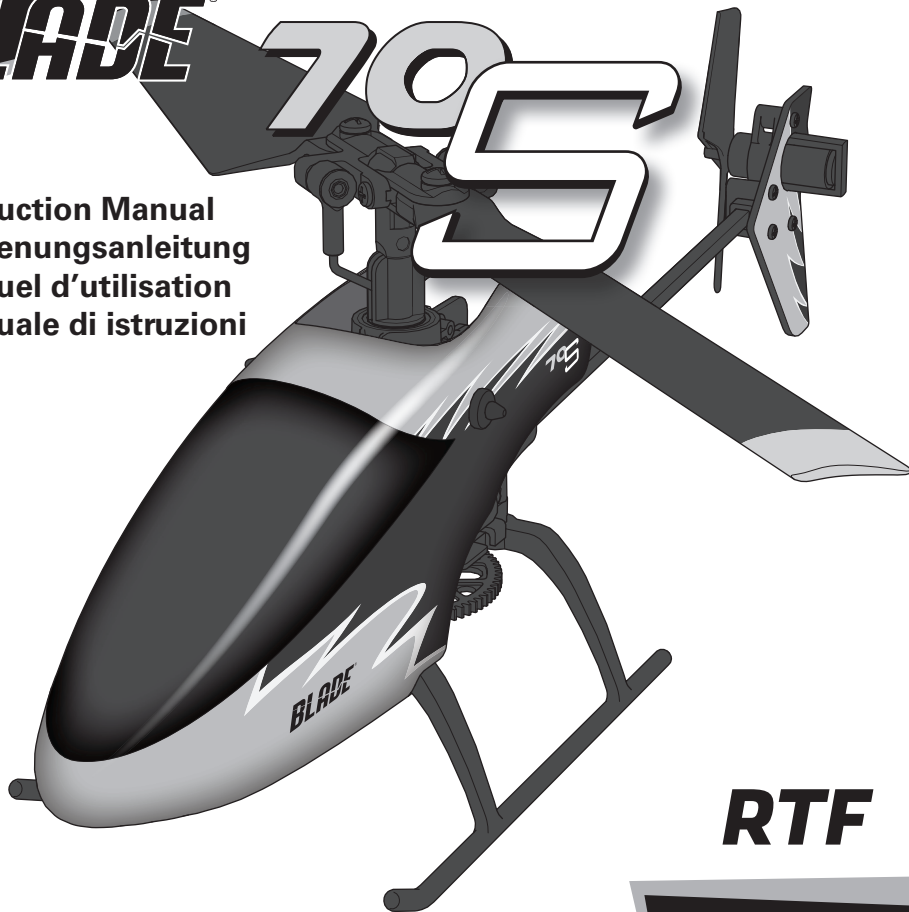

**RTF**

## NOTICE

All instructions, warranties and other collateral documents are subject to change at the sole discretion of Horizon Hobby, LLC. For up-to-date product literature, visit [horizonhobby.com](http://horizonhobby.com) and click on the support tab for this product.

## Meaning of Special Language

The following terms are used throughout the product literature to indicate various levels of potential harm when operating this product:

**WARNING:** Procedures, which if not properly followed, create the probability of property damage, collateral damage, and serious injury OR create a high probability of superficial injury.

**CAUTION:** Procedures, which if not properly followed, create the probability of physical property damage AND a possibility of serious injury.

**NOTICE:** Procedures, which if not properly followed, create a possibility of physical property damage AND a little or no possibility of injury.



**WARNING:** Read the ENTIRE instruction manual to become familiar with the features of the product before operating.

Failure to operate the product correctly can result in damage to the product, personal property and cause serious injury.

This is a sophisticated hobby product. It must be operated with caution and common sense and requires some basic mechanical ability. Failure to operate this Product in a safe and responsible manner could result in injury or damage to the product or other property. This product is not intended for use by children without direct adult supervision. Do not use with incompatible components or alter this product in any way outside of the instructions provided by Horizon Hobby, LLC. This manual contains instructions for safety, operation and maintenance. It is essential to read and follow all the instructions and warnings in the manual, prior to assembly, setup or use, in order to operate correctly and avoid damage or serious injury.

**Age Recommendation: Not for children under 14 years. This is not a toy.**

## Safety Precautions and Warnings

- Always keep a safe distance in all directions around your model to avoid collisions or injury. This model is controlled by a radio signal subject to interference from many sources outside your control. Interference can cause momentary loss of control.
- Always operate your model in open spaces away from full-size vehicles, traffic and people.
- Always carefully follow the directions and warnings for this and any optional support equipment (chargers, rechargeable battery packs, etc.).
- Always keep all chemicals, small parts and anything electrical out of the reach of children.
- Always avoid water exposure to all equipment not specifically designed and protected for this purpose. Moisture causes damage to electronics.
- Never place any portion of the model in your mouth as it could cause serious injury or even death.
- Never operate your model with low transmitter batteries.
- Always keep aircraft in sight and under control.
- Always move the throttle fully down at rotor strike.
- Always use fully charged batteries.
- Always keep transmitter powered on while aircraft is powered.
- Always remove batteries before disassembly.
- Always keep moving parts clean.
- Always keep parts dry.
- Always let parts cool after use before touching.
- Always remove batteries after use.
- Never operate aircraft with damaged wiring.
- Never touch moving parts.

# Table of Contents

Box Contents .....	3	Flying the 70 S.....	8
First Flight Preparation.....	4	Post-Flight Inspection and Maintenance Checklist.....	9
Flying Checklist .....	4	Troubleshooting Guide .....	9
Charging Warnings.....	4	Exploded View .....	11
Battery Charging.....	4	Parts Listings.....	11
Installing the Transmitter Batteries.....	5	Limited Warranty .....	12
Transmitter Control .....	5	Warranty and Service Contact Information .....	13
Installing the Flight Battery .....	6	FCC Information.....	13
Transmitter and Receiver Binding.....	6	IC Information.....	14
Understanding the Primary Flight Controls .....	7	Compliance Information for the European Union.....	14

## Specifications

<b>Length</b>	7 in (177.8mm)	<b>Tail Rotor Diameter</b>	.78 in (20mm)
<b>Height</b>	2.38 in (60.5mm)	<b>Flying Weight</b>	1.19 oz (34g)
<b>Main Rotor Diameter</b>	3.3 in (84mm)		

## Box Contents

- Blade® 70 S Helicopter
- 150mAh 1S 3.7V 40C Li-Po Battery (BLH4210)
- USB 1S Li-Po Charger (BLH4211)
- 2.4GHz Transmitter (BLH4217)
- 4 AA Batteries

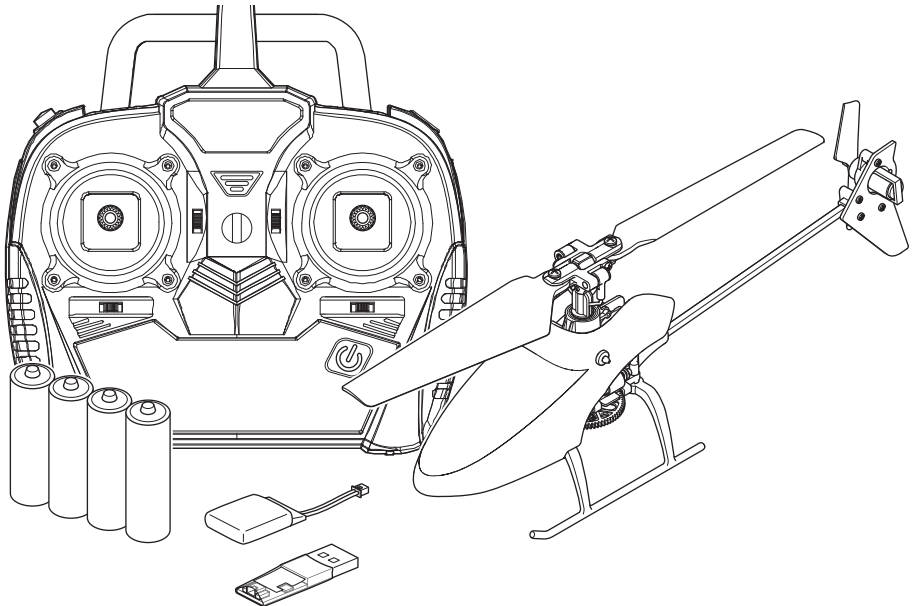

To receive product updates, special offers and more, register your product at [www.bladehelis.com](http://www.bladehelis.com).

## First Flight Preparation

- Remove and inspect contents
- Begin charging the flight battery
- Install the flight battery in the helicopter (once it has been fully charged)
- Bind your transmitter to the helicopter
- Familiarize yourself with the controls
- Find a suitable area for flying

## Charging Warnings

**⚠ CAUTION:** All instructions and warnings must be followed exactly. Mishandling of Li-Po batteries can result in a fire, personal injury and/or property damage.

- **NEVER LEAVE CHARGING BATTERIES UNATTENDED.**
- **NEVER CHARGE BATTERIES OVERNIGHT.**
- By handling, charging or using the included Li-Po battery, you assume all risks associated with lithium batteries.
- If at any time the battery begins to balloon or swell, discontinue use immediately. If charging or discharging, discontinue and disconnect. Continuing to use, charge or discharge a battery that is ballooning or swelling can result in fire.
- Always store the battery at room temperature in a dry area for best results.
- Always transport or temporarily store the battery in a temperature range of 40–120° F (5–49° C).
- Do not store battery or model in a car or direct sunlight. If stored in a hot car, the battery can be damaged or even catch fire.
- Always charge batteries away from flammable materials.

## Battery Charging

Refer to the charging warnings before attempting to charge the aircraft battery. Your aircraft comes with a 1S 3.7V DC USB Li-Po battery charger and 1S 3.7V 150mAh 40C Li-Po battery.

### Charger Specifications

Input Voltage	5-8V
Input Current	1A Maximum
Output Charging Current	300mA

1. Insert the charger into a computer USB port or a USB power supply, such as those used to charge cellular phones. Always confirm the output voltage of your USB power supply conforms to the charger specifications above before attempting to connect the charger.



## Flying Checklist

- Always turn the transmitter on first**
- Plug the flight battery into the helicopter
- Allow the helicopter to initialize and arm properly
- Fly the model
- Land the model
- Unplug the flight battery
- Always turn the transmitter off last**

- Always inspect the battery before charging.
- Always disconnect the battery after charging, and let the charger cool between charges.
- Always constantly monitor the temperature of the battery pack while charging.
- **ONLY USE A CHARGER SPECIFICALLY DESIGNED TO CHARGE LI-PO BATTERIES.** Failure to charge the battery with a compatible charger may cause a fire resulting in personal injury and/or property damage.
- Never discharge Li-Po cells to below 3V under load.
- Never cover warning labels with hook and loop strips.
- Never charge batteries outside recommended levels.
- Never charge damaged batteries.
- Never attempt to dismantle or alter the charger.
- Never allow minors to charge battery packs.
- Never charge batteries in extremely hot or cold places (recommended between 40–120° F or (5–49° C) or place in direct sunlight.

2. Connect the battery micro connector to the charge port of the battery charger.

### LED Indications

When you make the connection successfully, the LED on the charger glows solid red, indicating charging has begun. Charging a fully discharged (not over-discharged) 150mAh battery takes approximately 30 minutes. The LED glows solid green when the charge is complete.

**Solid Red:** Charging

**Solid Green:** Charging complete

**⚠ CAUTION:** Once charging is complete, immediately remove the battery. Never leave a battery connected to the charger.

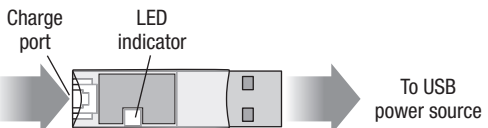

## Installing the Transmitter Batteries

The LED indicator flashes and the transmitter beeps as the battery voltage drops.

Replace the 4 AA transmitter batteries when the transmitter begins to beep.

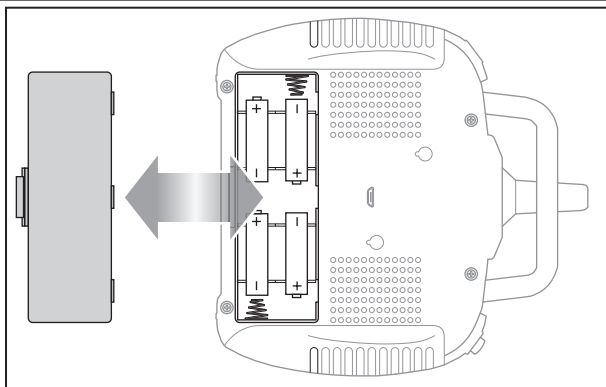

## Transmitter Control

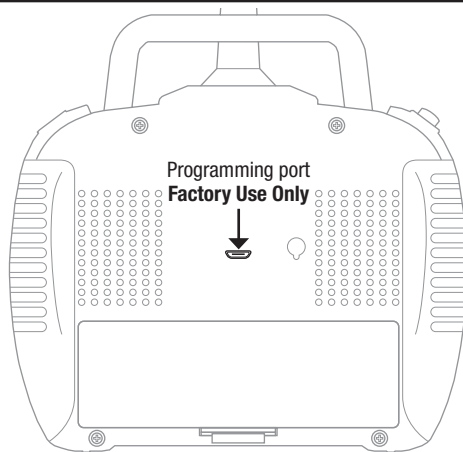
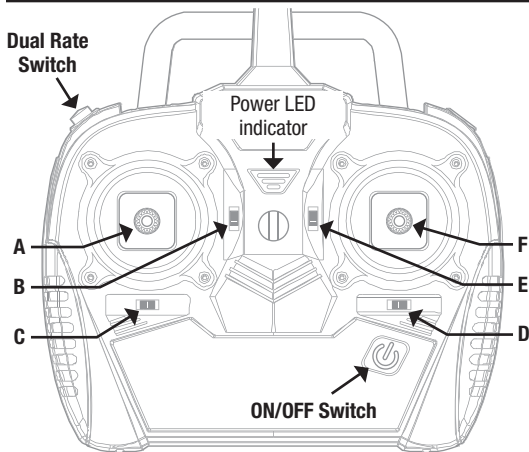

	A	B	C	D	E	F
Mode 1	Rudder (Left/Right) Elevator (Up/Down)	Elevator Trim	Rudder Trim	Aileron Trim	Throttle Trim	Aileron (Left/Right) Throttle (Up/Down)
Mode 2	Rudder (Left/Right) Throttle (Up/Down)	Throttle Trim	Rudder Trim	Aileron Trim	Elevator Trim	Aileron (Left/Right) Elevator (Up/Down)

### Adjusting Flight Trims

The transmitter beeps every time one of the trim buttons is pressed, until the trim has reached the upper or lower range limit. The middle or neutral trim position is heard as a longer tone. The end of the trim range is indicated by no sound when the button is pressed.

### Dual Rate Selection

The control sensitivity can be changed by pressing and releasing the dual rate button. The transmitter beeps once to indicate low rates and twice to indicate high rates. The default setting when the transmitter is powered on is low rates.

## Installing the Flight Battery

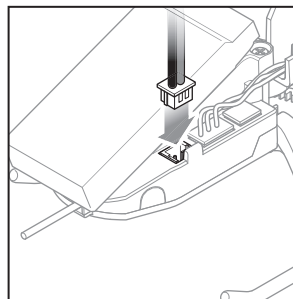
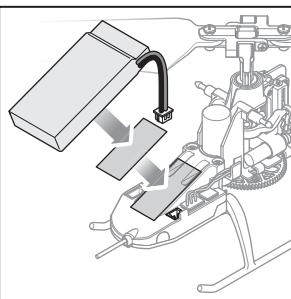
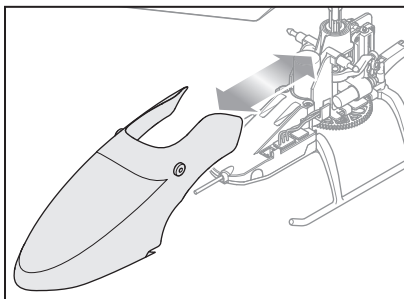

1. Lower the throttle stick to the lowest position.
2. Power ON the transmitter.
3. Center all trims. The trims are centered when you hear a longer tone while pressing the trim button. Move the trim in both directions until you hear the longer tone.
4. Remove the canopy from the aircraft.
5. Install the flight battery using hook and loop tape. The loop material should be attached to the battery and the hook material should be attached to the airframe.
6. Insert the battery power lead into the power port of the aircraft, noting proper polarity.



**CAUTION:** Connecting the battery to the flight control board with reversed polarity will cause damage to the control board, the battery or both. Damage caused by incorrectly connecting the battery is not covered under warranty.

7. Place the helicopter on a flat, level surface and leave it still until the green LED glows solid and the blue LED flashes slowly, indicating initialization is complete and the aircraft is in standby mode. If the green LED flashes rapidly and then goes off, refer to the Transmitter and Receiver Binding section.

8. Install the canopy.

If you experience problems during initialization, refer to the Troubleshooting Guide at the back of the manual.



**CAUTION:** Always disconnect the Li-Po battery from the aircraft when not flying to avoid over-discharging the battery. Batteries discharged to a voltage lower than the lowest approved voltage may become damaged, resulting in loss of performance and potential fire when batteries are charged.

## Transmitter and Receiver Binding

Binding is the process of programming the aircraft receiver to recognize the GUID (Globally Unique Identifier) code of a single specific transmitter. The transmitter is bound to the model at the factory.

If for any reason you need to re-bind your aircraft to the transmitter, follow the directions in the Binding Procedure table.

If you encounter problems, refer to the troubleshooting guide for other instructions. If needed, contact the appropriate Horizon Hobby Product Support office.

### Binding Procedure

1. Disconnect the flight battery from the helicopter.
2. Power off the transmitter.
3. Connect the flight battery to the helicopter. The green LED on the aircraft flashes rapidly for about 5 seconds, indicating the aircraft is in bind mode.
4. Press and hold the right rudder trim button and power on the transmitter.
5. Release the right rudder trim button when the green LED goes off.
6. The green LED will glow solid, indicating the transmitter and aircraft are successfully bound.
7. Disconnect the flight battery and power the transmitter off.

# Understanding the Primary Flight Controls

If you are not familiar with the controls of the 70 S, take a few minutes to familiarize yourself with them before attempting your first flight.

## Throttle

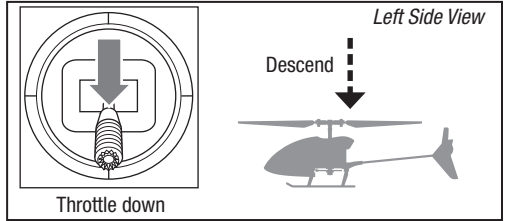
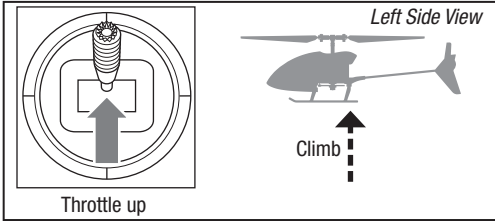

## Rudder

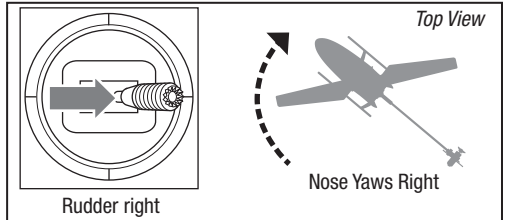
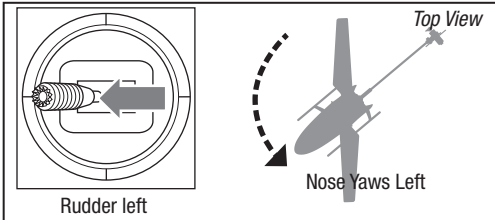

## Elevator (Cyclic)

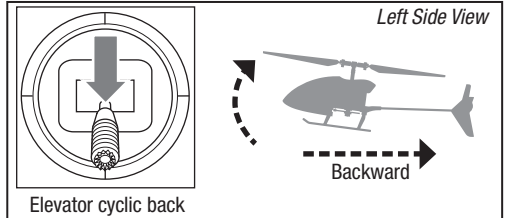
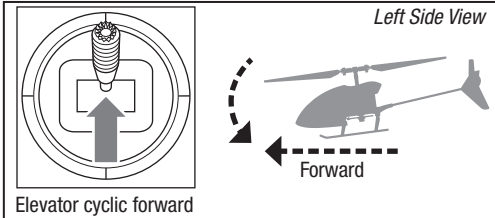

## Aileron (Cyclic)

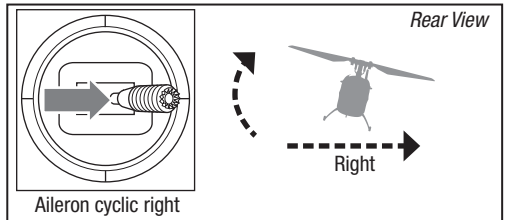
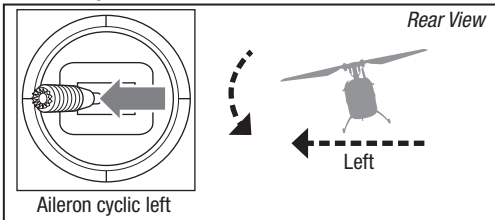

# Flying the 70 S

## Consult your local laws and ordinances before choosing a location to fly your aircraft.

If this is your first helicopter, we suggest getting assistance from an experienced helicopter pilot or flying club until you are comfortable flying alone.

We recommend flying your aircraft outside in calm winds or inside a large gymnasium. Always avoid flying near houses, trees, wires and buildings. You should also be careful to avoid flying in areas where there are many people, such as busy parks, schoolyards or soccer fields.

It is best to fly from a smooth flat surface as this will allow the model to slide without tipping over. Keep the helicopter approximately 2 ft (600mm) above the ground. Keep the tail pointed toward you during initial flights to keep the control orientation consistent. If you become disoriented while flying, slowly lower the throttle stick to land softly.

During initial flights, only attempt takeoff, landing and hovering in one spot.

## Takeoff

Place the model onto a flat, level, obstacle free surface and walk back 30 feet (10 meters). The model has a safety lock which disables the throttle both at initial startup and whenever the model does not receive any throttle input for greater than 10 seconds. The blue LED on the aircraft will blink slowly to indicate the throttle is locked. To unlock the throttle fully lower the throttle stick. Push the rudder control fully to the right and hold for 3 seconds. The blue LED on the aircraft will flash rapidly indicating the throttle is active. The aircraft is now ready for flight and will respond to any throttle input.

**IMPORTANT:** If the main motor or tail motor do not startup properly when throttle is first applied after the throttle is unlocked, immediately return the throttle to idle and try again. If the problem persists, disconnect the flight battery, check for binding in the gear train and ensure no wires or debris have become entangled within the gears.

Slowly increase the throttle until the model is approximately 2 ft. (600mm) off the ground and check the trim so the model flies as desired. Once the trim is adjusted, begin flying the model.

## Hovering

Making small corrections on the transmitter, try to hold the helicopter in one spot. If flying in calm winds, the model should require almost no corrective inputs. After moving the cyclic stick and returning it to center, the model should level itself. The model may continue to move due to inertia. Move the cycle stick in the opposite direction to stop the movement.

After you become comfortable hovering, you can progress into flying the model to different locations, keeping the tail pointed towards you at all times. You can also ascend and descend using the throttle stick. Once you're comfortable with these maneuvers, you can attempt flying with the tail in different orientations. It is important to keep in mind that the flight control inputs will rotate with the helicopter, so always try to picture the control inputs relative to the nose of the helicopter. For example, forward will always drop the nose of the helicopter.

The average flight time of the aircraft using the recommended battery is approximately 4 minutes, depending on how aggressively the aircraft is flown.

## Low Voltage Cutoff (LVC)

LVC decreases the power to the motors and the green LED flashes slowly when the flight battery voltage gets low. When the green LED flashes or the motor power decreases land the aircraft immediately and recharge the flight battery.

LVC does not prevent the battery from over-discharge during storage.

**NOTICE:** Repeated flying to LVC may damage the battery.

## Landing

To land, slowly decrease the throttle while in a low-level hover until the aircraft touches down. After landing, disconnect and remove the battery from the aircraft to prevent trickle discharge. Fully charge your battery before storing it. During storage, make sure the battery charge does not fall below 3V per cell.



# Post-Flight Inspection and Maintenance Checklist

<b>Ball Links</b>	Make sure the plastic ball link holds the control ball, but is not tight (binding) on the ball. When a link is too loose on the ball, it can separate from the ball during flight and cause a crash. Replace worn ball links before they fail.
<b>Cleaning</b>	Make sure the battery is not connected before cleaning. Remove dust and debris with a soft brush or a dry, lint-free cloth.
<b>Bearings</b>	Replace bearings when they become notchy (sticky in places when turning) or draggy.
<b>Wiring</b>	Make sure the wiring does not contact moving parts. Replace damaged wiring and loose connectors.
<b>Fasteners</b>	Make sure there are no loose screws, other fasteners or connectors. Do not over-tighten metal screws in plastic parts. Tighten screws so the parts are mated together, then turn the screw only 1/8th of a turn more.
<b>Rotors</b>	Make sure there is no damage to rotor blades and other parts which move at high speed. Damage to these parts includes cracks, burrs, chips or scratches. Replace damaged parts before flying. Verify both main rotor blades have the correct and equal tension in the blade grips. When the helicopter is held up sideways, the main blades should support their own weight. When the helicopter is shaken lightly, the blades should fall.
<b>Tail</b>	Inspect the tail rotor for damage and replace if necessary. Inspect the tail boom for any damage and replace if necessary.
<b>Mechanics</b>	Inspect the main frame and landing gear for damage and replace if necessary. Check the mainshaft for vertical play. Verify that the main gear mesh is correct and that no tight spots exist in the 360 degree rotation. Replace components as necessary.

## Troubleshooting Guide

Problem	Possible Cause	Solution
Helicopter control response is inconsistent or requires extra trim to neutralize movement	Aircraft was not initialized properly	Disconnect the flight battery, center the transmitter control trims and re-initialize the helicopter
	Vibration is interfering with the sensor operation	Check all rotating parts for damage and replace as necessary Make sure the receiver unit is securely attached to the frame
Helicopter will not respond to throttle	Throttle is inactive due to safety lock	See Takeoff in the Flying the 70 S section for instructions to activate the throttle
	Throttle too high and/or throttle trim is too high	Disconnect the flight battery, place the throttle stick in the lowest position and lower the throttle trim a few clicks. Connect the flight battery and allow the model to initialize
	Helicopter moved during initialization	Disconnect the flight battery and re-initialize the helicopter while keeping the helicopter from moving
Helicopter has reduced flight time or is underpowered	Flight battery charge is low	Completely recharge the flight battery
	Flight battery is damaged	Replace the flight battery and follow the flight battery instructions
	Flight conditions might be too cold	Make sure the battery is warm (room temperature) before use
	Debris in or around the rotating parts	Clean all rotating parts
Green LED on the aircraft flashes rapidly then goes off and the aircraft will not respond to transmitter (during binding)	Bind switch or button was not held while transmitter was powered on	Power off transmitter and repeat bind process
	Aircraft or transmitter is too close to large metal object, wireless source or another transmitter	Move aircraft and transmitter to another location and attempt binding again
LED on the flight control board flashes rapidly and the helicopter will not respond to the transmitter (after binding)	Less than a 5-second wait between first powering on the transmitter and connecting the flight battery to the helicopter	Leave the transmitter powered on. Disconnect and reconnect the flight battery to the helicopter
	Flight battery or transmitter battery charge is too low	Replace or recharge batteries
	Aircraft or transmitter is too close to large metal object, wireless source or another transmitter	Move aircraft and transmitter to another location and attempt binding again

<b>Problem</b>	<b>Possible Cause</b>	<b>Solution</b>
Helicopter vibrates or shakes in flight	Damaged rotor blades, spindle or blade grips	Check main rotor blades and blade grips for cracks or chips. Replace damaged parts. Replace bent spindle
Random movements in flight	Vibration	Verify the receiver is properly attached to the helicopter. Inspect and balance all rotating components. Verify the main shaft and tail rotor are not damaged or bent. Inspect mechanics for broken or damaged parts and replace as necessary
Tail oscillation/wag or poor performance	Damaged tail rotor, tailboom, main gear mesh, main shaft, loose bolts, vibration	Inspect the tail rotor for damage. Inspect the tail boom for cracks. Verify main gear mesh and ensure no tight spots in the mesh through full rotation. Replace any damaged or worn components
Drift in wind	Normal	The model will drift with the wind but should remain level in flight. Simply hold the cyclic stick in the necessary position to keep the model stationary. The model must lean into the wind to remain stationary. If the model remains level then it will drift with the wind
Model does not return to level when the sticks are centered	Model was not initialized on a level surface	Re-initialize the model on a level surface
	Model was not taken off of a level surface	Always lift off from a level surface
Severe vibration	Main shaft is bent	Check the main shaft for damage and replace if necessary
	Rotating component out of balance	Check the main shaft, tail rotor, main rotor blades and main frame for damage and replace as necessary

## Exploded View

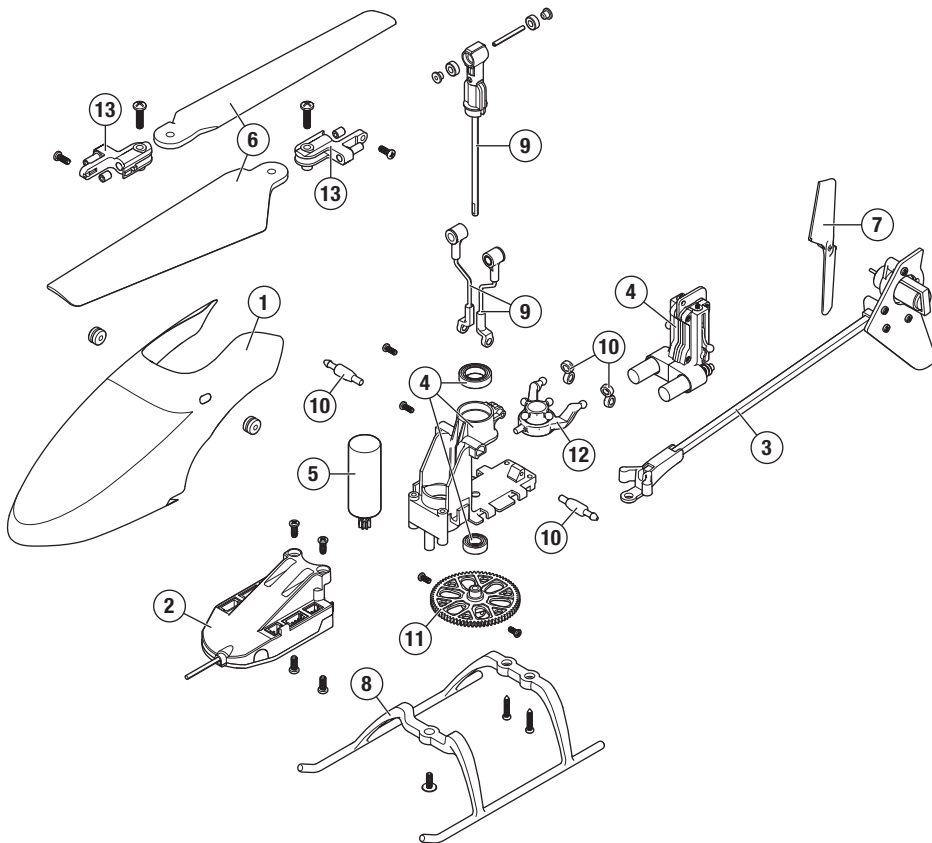

## Parts Listings

Part #	Description
BLH4200	Blade 70 S RTF
1 BLH4201	Replacement Canopy: 70 S
2 BLH4202	Replacement flight controller w/ Case: 70 S
3 BLH4203	Replacement Tail Assembly w/Motor: 70 S
4 BLH4204	Replacement main frame with servos: 70 S
5 BLH4205	Replacement Main Motor : 70 S
6 BLH4206	Main rotor blades (2): 70 S
7 BLH4207	Replacement Tail Blades (4): 70 S

Part #	Description
8 BLH4208	Replacement Landing Gear(2): 70 S
9 BLH4209	Complete Rotor Head
10 BLH4212	Body Post/Servo Linkage: 70 S
11 BLH4213	Replacement Main Gear (2): 70 S
12 BLH4214	Swash Plate: 70 S
13 BLH4215	Blade Grips w/ Hardware: 70 S
BLH4210	Replacement battery: 70 S
BLH4211	USB 1s Charger: 70 S

# Limited Warranty

## What this Warranty Covers

Horizon Hobby, LLC, (Horizon) warrants to the original purchaser that the product purchased (the "Product") will be free from defects in materials and workmanship at the date of purchase.

## What is Not Covered

This warranty is not transferable and does not cover (i) cosmetic damage, (ii) damage due to acts of God, accident, misuse, abuse, negligence, commercial use, or due to improper use, installation, operation or maintenance, (iii) modification of or to any part of the Product, (iv) attempted service by anyone other than a Horizon Hobby authorized service center, (v) Product not purchased from an authorized Horizon dealer, (vi) Product not compliant with applicable technical regulations, or (vii) use that violates any applicable laws, rules, or regulations.

OTHER THAN THE EXPRESS WARRANTY ABOVE, HORIZON MAKES NO OTHER WARRANTY OR REPRESENTATION, AND HEREBY DISCLAIMS ANY AND ALL IMPLIED WARRANTIES, INCLUDING, WITHOUT LIMITATION, THE IMPLIED WARRANTIES OF NON-INFRINGEMENT, MERCHANTABILITY AND FITNESS FOR A PARTICULAR PURPOSE. THE PURCHASER ACKNOWLEDGES THAT THEY ALONE HAVE DETERMINED THAT THE PRODUCT WILL SUITABLY MEET THE REQUIREMENTS OF THE PURCHASER'S INTENDED USE.

## Purchaser's Remedy

Horizon's sole obligation and purchaser's sole and exclusive remedy shall be that Horizon will, at its option, either (i) service, or (ii) replace, any product determined by Horizon to be defective. Horizon reserves the right to inspect any and all Product(s) involved in a warranty claim. Service or replacement decisions are at the sole discretion of Horizon. Proof of purchase is required for all warranty claims. SERVICE OR REPLACEMENT AS PROVIDED UNDER THIS WARRANTY IS THE PURCHASER'S SOLE AND EXCLUSIVE REMEDY.

## Limitation of Liability

HORIZON SHALL NOT BE LIABLE FOR SPECIAL, INDIRECT, INCIDENTAL OR CONSEQUENTIAL DAMAGES, LOSS OF PROFITS OR PRODUCTION OR COMMERCIAL LOSS IN ANY WAY, REGARDLESS OF WHETHER SUCH CLAIM IS BASED IN CONTRACT, WARRANTY, TORT, NEGLIGENCE, STRICT LIABILITY OR ANY OTHER THEORY OF LIABILITY, EVEN IF HORIZON HAS BEEN ADVISED OF THE POSSIBILITY OF SUCH DAMAGES. Further, in no event shall the liability of Horizon exceed the individual price of the Product on which liability is asserted. As Horizon has no control over use, setup, final assembly, modification or misuse, no liability shall be assumed nor accepted for any resulting damage or injury. By the act of use, setup or assembly, the user accepts all resulting liability. If you as the purchaser or user are not prepared to accept the liability associated with the use of the Product, purchaser is advised to return the Product immediately in new and unused condition to the place of purchase.

## Law

These terms are governed by Illinois law (without regard to conflict of law principals). This warranty gives you specific legal rights, and you may also have other rights which vary from state to state. Horizon reserves the right to change or modify this warranty at any time without notice.

## WARRANTY SERVICES

### Questions, Assistance, and Services

Your local hobby store and/or place of purchase cannot provide warranty support or service. Once assembly, setup or use of the Product has been started, you must contact your local distributor or Horizon directly. This will enable Horizon to better answer your questions and service you in the event that you may need any assistance. For questions or assistance, please visit our website at [www.horizonhobby.com](http://www.horizonhobby.com), submit a Product Support Inquiry, or call the toll free telephone number referenced in the Warranty and Service Contact Information section to speak with a Product Support representative.

### Inspection or Services

If this Product needs to be inspected or serviced and is compliant in the country you live and use the Product in, please use the Horizon Online Service Request submission process found on our website or call Horizon to obtain a Return Merchandise Authorization (RMA) number. Pack the Product securely using a shipping carton. Please note that original boxes may be included, but are not designed to withstand the rigors of shipping without additional protection. Ship via a carrier that provides tracking and insurance for lost or damaged parcels, as Horizon is not responsible for merchandise until it arrives and is accepted at our facility. An Online Service Request is available at [http://www.horizonhobby.com/content/service-center\\_renderer-service-center](http://www.horizonhobby.com/content/service-center_renderer-service-center). If you do not have internet access, please contact Horizon Product Support to obtain a RMA number along with instructions for submitting your product for service. When calling Horizon, you will be asked to provide your complete name, street address, email address and phone number where you can be reached during business hours. When sending product into Horizon, please include your RMA number, a list of the included items, and a brief summary of the problem. A copy of your original sales receipt must be included for warranty consideration. Be sure your name, address, and RMA number are clearly written on the outside of the shipping carton.

**NOTICE:** Do not ship Li-Po batteries to Horizon. If you have any issue with a Li-Po battery, please contact the appropriate Horizon Product Support office.

### Warranty Requirements

**For Warranty consideration, you must include your original sales receipt verifying the proof-of-purchase date.** Provided warranty conditions have been met, your Product will be serviced or replaced free of charge. Service or replacement decisions are at the sole discretion of Horizon.

### Non-Warranty Service

**Should your service not be covered by warranty, service will be completed and payment will be required without notification or estimate of the expense unless the expense exceeds 50% of the retail purchase cost.** By submitting the item for service you are agreeing to payment of the service without notification. Service estimates are available upon request. You must include this request with your item submitted for service. Non-warranty service estimates will be billed a minimum of ½ hour of labor. In addition you will be billed for return freight.

Horizon accepts money orders and cashier's checks, as well as Visa, MasterCard, American Express, and Discover cards. By submitting any item to Horizon for service, you are agreeing to Horizon's Terms and Conditions found on our website [http://www.horizonhobby.com/content/service-center\\_render-service-center](http://www.horizonhobby.com/content/service-center_render-service-center).

**ATTENTION: Horizon service is limited to Product compliant in the country of use and ownership. If received, a non-compliant Product will not be serviced. Further, the sender will be responsible for arranging return shipment of the un-serviced Product, through a carrier of the sender's choice and at the sender's expense. Horizon will hold non-compliant Product for a period of 60 days from notification, after which it will be discarded.**

10/15

## Warranty and Service Contact Information

Country of Purchase	Horizon Hobby	Contact Information	Address
United States of America	Horizon Service Center (Repairs and Repair Requests)	<a href="http://servicecenter.horizonhobby.com/RequestForm/">servicecenter.horizonhobby.com/RequestForm/</a>	4105 Fieldstone Rd Champaign, Illinois, 61822 USA
	Horizon Product Support (Product Technical Assistance)	<a href="mailto:productsupport@horizonhobby.com">productsupport@horizonhobby.com</a> 877-504-0233	
	Sales	<a href="mailto:websales@horizonhobby.com">websales@horizonhobby.com</a> 800-338-4639	
European Union	Horizon Technischer Service Sales: Horizon Hobby GmbH	<a href="mailto:service@horizonhobby.eu">service@horizonhobby.eu</a> +49 (0) 4121 2655 100	Hanskampring 9 D 22885 Barsbüttel, Germany

## FCC Information

### FCC ID: 2ANYZ-ESKY007324

This equipment has been tested and found to comply with the limits for Part 15 of the FCC rules. These limits are designed to provide reasonable protection against harmful interference in a residential installation. This equipment generates uses and can radiate radio frequency energy and, if not installed and used in accordance with the instructions, may cause harmful interference to radio communications.

However, there is no guarantee that interference will not occur in a particular installation. If this equipment does cause harmful interference to radio or television reception, which can be determined by turning the equipment off and on, the user is encouraged to try to correct the interference by one or more of the following measures:

- Reorient or relocate the receiving antenna.
- Increase the separation between the equipment and receiver.
- Connect the equipment to an outlet on a circuit different from that to which the receiver is connected.

This device complies with part 15 of the FCC rules. Operation is subject to the following two conditions: (1) This device may not cause harmful interference, and (2) this device must accept any interference received, including interference that may cause undesired operation.

**NOTICE:** Modifications to this product will void the user's authority to operate this equipment.

## IC Information

---

### IC: 23279-BLH4217

This device complies with Industry Canada licence-exempt RSS standard(s). Operation is subject to the following two conditions:

(1) this device may not cause interference, and (2) this device must accept any interference, including interference that may cause undesired operation of the device.”

## Compliance Information for the European Union

---



### EU Compliance Statement:

Horizon Hobby, LLC hereby declares that this product is in compliance with the essential requirements and other relevant provisions of the RED and EMC Directives.

A copy of the EU Declaration of Conformity is available online at: <http://www.horizonhobby.com/content/support-render-compliance>.

### Instructions for disposal of WEEE by users in the European Union



This product must not be disposed of with other waste. Instead, it is the user's responsibility to dispose of their waste equipment by handing it over to a designated collections point for the recycling of waste electrical and electronic equipment. The separate collection and recycling of your waste

equipment at the time of disposal will help to conserve natural resources and make sure that it is recycled in a manner that protects human health and the environment. For more information about where you can drop off your waste equipment for recycling, please contact your local city office, your household waste disposal service or where you purchased the product.



E328

©2017 Horizon Hobby, LLC.

Blade is a registered trademark of Horizon Hobby, LLC.

All other trademarks, service marks and logos are property of their respective owners. Patents pending.

Created 10/17

57140

BLH4200